

Why not go out on a limb? Isn't that where the fruit is?

- Frank Scully



5627 University Way NE • Seattle • 206.527.4822 • www.rodcycle.com

R+E CYCLES NEWS • THE NEWSLETTER OF CYCLING VALUES! SEPT/OCT. 2005

Like a Fine Wine.....NOT!

Are you waiting for your old bike to improve with age?

Come on, we know you're out there, we see you in the repair shop every day. Aren't you tired of that old, heavy bike? Tired of the repair bills, the broken spokes, or the old fashioned shifters? Does your neck, back or butt hurt when you go riding? Do all of your friends laugh at your bike? Or, maybe you have a friend in this...unfortunate situation. Well, now's your chance to do something about it!



We'll give you (or them) \$175 for that old bike, no matter what it is, when you push, pull or drag it in to R+E Cycles and buy a Rodriguez! That's right! Your old bike is worth \$175 in trade, no matter how old, broken, or outdated it is!

Think we're crazy? That's kind of what our accountant thought when we told her we were going to offer this fantastic promotion last year, so this year we just didn't tell her. We want to see more people enjoy cycling on a new Rodriguez! Here's how it works. Just bring in that old junker. We'll measure you up for a new Rodriguez. It's that simple. You'll ride away on a comfortable, fast, up-to-date Rodriguez that will make all of your friends drool!



You'll have to hurry, though, this offer is only good through October 15th!

Where's Willie?

At R+E Cycles...of course!

For the last 2 winters, Willie has entertained and informed you all about his adventures by doing slide shows in R+E Cycles. Well, this winter is a little different. Willie is going on an extended tour out of the country. I managed to talk with him right before he left for a short trip to Idaho (everyone seems to be going to Idaho this summer). We've arranged to have him come this October, before he leaves and share with you the secrets of bicycle travelling.

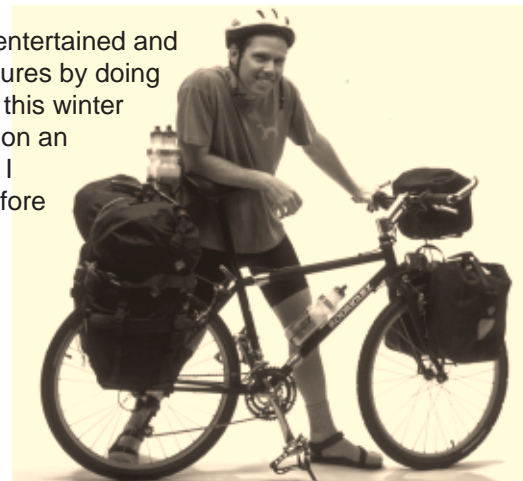

So, now's your chance!

Come and talk touring with Willie Weir - columnist for Adventure Cyclist magazine. Willie will cover everything from travel philosophy to packing tips. Bring your future trip plans, your dreams, your questions and your sense of adventure.

Thursday, October 13. 6:30 - 9:00PM

Class size limited to 30, pre-registration is required.

To register, call the shop at 206-527-4822, or visit our web site to download a registration form. www.rodcycle.com

\$25 admission. All admission proceeds will be donated to the Red Cross for their efforts in the hurricane Katrina disaster relief.

HOURS

Monday ~ Closed
Tuesday - Friday 12 ~ 6
Saturday - 10 ~ 5
Sunday ~ Closed
by Appointment ~ anytime

Inside This Issue:

ReincarnationPg. 1
Tandem Tech Talk.....Pg. 7
Willie Weir ClinicsPg. 1
Repair ClassesPg. 2
Time to Winterize.....Pg. 4
Our favorite LightPg. 4
The World is WaitingPg. 3
What's the ScoopPg. 8

R+E Cycles
5627 University Way NE
Seattle, WA, 98105
206-527-4822
fax 206-527-8931
email Sales@rodcycle.com



The only shop around with a real coffee shop built right in.

Rain Stain?

Are you tired of the rain stain on your back after a ride in the Seattle winter? Be honest, do you use the rain as an excuse to cancel your ride and drive your car instead? Well, this winter we're going to help solve that problem by giving you a 10% discount on all fenders in stock! No more excuses get in here and ride! Reg. \$35-\$55



Fenders 10% OFF!

Offer good with coupon only. No cash value. Not good with any other offer. Expires 10/15/04

More Excuses?

"I'd ride in the rain, but I don't have a good rain jacket". I've heard this one before, so here we go. Use this coupon to get the Burley Rock Point rain jacket (the only one that works) and save \$30 in the process! Reg. \$170



With Coupon Just \$139.99

Offer good with coupon only. No cash value. Not good with any other offer. Expires 10/15/04

How Bright Are You?

Pretty darn bright if you're one of the first 25 people to bring in this coupon and spend \$20 or more at R+E Cycles!

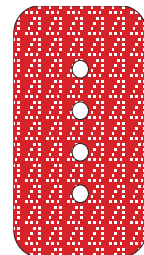

If you're one of the first 25 people to bring in this coupon with the mailing label attached, you'll receive a free Onguard flashing tail light with your purchase of \$20 or more.

Free is a very good price!

\$12 Value

This is not an in store coupon. Coupon must contain the printed mailing label. No cash value. Limited to first 25 coupons. Expires October 15, 2005

PRSR STD
US Postage
PAID
Seattle, WA
Permit No. 231

BICYCLE REPAIR CLASSES



At Seattle Bike Repair, we offer a range of classes to people at all levels of bicycle knowledge. From the Roadside Repair class to the Overhaul class, you can learn anything and everything about your bike! Some classes are scheduled, and some consist of personalized instruction scheduled by appointment for your convenience. Get some friends together and learn something new and fun!

If you have an idea for a class that you'd like to take this winter, give us a call, and we'll see what we can do to put one together for you.

To sign-up for a class call us at 206-527-0360

Road Side Repair \$45

This one-evening, 2-3 hour class covers the basics of repairing your bike on the road. We will cover most of the basic repairs that strand people along the road. Learn how to:

- Fix a flat tire
- Fix a broken chain
- Make a minor adjustment to your shifting & brakes
- Know what tools and parts to carry with you on your bike

Next dates are: Sept. 13, 27, Oct. 11, 25

To sign-up call John at 206-527-0360.

(This class is limited to 8 people)

See Cancellation Policy at bottom of page



Routine Maintenance \$65

A clean bike is a happy bike. This one-evening, 2-3 hour class covers:

- The basics of proper maintenance 'the secrets of a pro mechanic'
- How to quickly and efficiently clean your bike
- What to look for regarding worn-out parts
- How to extend the life of your bicycles' components
- Performing simple adjustments on brakes and shifters

Next Dates are: Sept. 22

Groups of 2 to 5 by appointment.

To sign up, call 206-527-0360.

(This class is limited to 5 people)

See Cancellation Policy at bottom of page



Getting Greasy! \$150

This two-evening, personalized course is the perfect class for the person who wants to learn how to thoroughly care for their drivetrain (chain, bottom bracket, cogs etc...).

During the class, you will get greasy! You'll learn the following and more:

- Basic alignment check (rear triangle and dropouts)
- Remove and clean your chain
- Hub bearing adjustments
- Remove and clean your cranks and derailleurs
- Bottom bracket adjustment
- Thorough shifting adjustments
- How to use several specific shop tools

This class is by appointment with John.

To sign up, call 206-527-0360.

Groups discounts available.

All classes require 100% deposit for registration.

See Cancellation Policy at bottom of page

Although there are no prerequisites for taking this course, we have a recommendation: We recommend that people either take the 'Road Side Repair' class before the 'Getting Greasy!' class, or be very familiar with everything in the 'Road Side Repair' class.



The Overhaul Course \$250

This 6-hour course is the class for the person who has the skills that the 'Getting Greasy' course covers, but wants to learn everything there is to know about their bike! In this class you will strip your bike and completely overhaul it. The price includes new bearings all around, and new cables & housings all around (other parts extra if necessary). Whew! Sounds like fun. Below are some of the things you'll learn in this extensive course:

- How to completely rebuild your hubs
- How to completely rebuild your bottom bracket
- How to completely rebuild your head set
- How to inspect your bearing surfaces for wear
- How to use bicycle-specific tools
- Fix a broken spoke
- How to align your dropouts on the frame & fork
- How to align your derailleur hanger
- How to install & pre-stretch all the cables

This class is by appointment with John.

To sign-up call 206-527-0360.

Groups discounts available.

All classes require 100% deposit for registration.

See Cancellation Policy at bottom of page

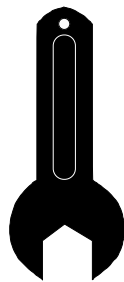

WARNING: THIS CLASS IS NOT FOR EVERYONE

Prerequisites for taking the overhaul course are:

If you are not comfortable with performing basic maintenance on your bicycle already, this class is too advanced. We recommend that people either take the 'Getting Greasy' class before the 'overhaul' class, or be very familiar with everything in those classes.

Class Cancellation Policy

For Getting Greasy and Overhaul Classes:

Cancellations must be made at least one week prior to class date in order to receive 90% refund. Other cancellations are nonrefundable.

For Roadside Repair Classes & Routine Maintenance:

Cancellations must be made at least 2 days prior to class date in order to receive 90% refund. Other cancellations are nonrefundable.

There's Still Some Life in That Old Girl!

It's the special you've been waiting for!

OK, so you've got an old bike, but it's not ready for the dumpster, and besides, you're emotionally attached to it like an old cat. You might even have named him or her, thereby cementing your relationship for at least another 5 years. Well that's OK, we understand, and we've got something great for you.

A few years back, Matt (thanks Matt) in the repair shop suggested to me that we run a coupon for a complete overhaul and paint job. We called it "reincarnate your old steed". The winter is our slow time, and I decided that it would be better to keep us busy so we wouldn't have to do as many seasonal layoffs as in the past. It worked well, so this winter we're offering it once again.

It turned out to be a win/win situation for the customers as well as the repair and paint shop! That one little coupon kept us going strong, and gave those customers who took us up on it a fantastic looking, as well as fantastic performing bicycle! One guy brought in a beautiful old Mercian, maybe 20 years old or more, and when it was done, it looked like I'd just stepped out of a time machine into 1980. Several women brought in Stellars from the early years (1996-97) and had them custom painted and overhauled with this coupon. One in particular had the bike painted Sunrise Yellow, and the old brakes were white. She originally thought she should buy some new brakes for it, but I suggested that we paint the white ones to match her new color. Well, it worked beautifully, and she has a very classy looking 1996 Stellar! The list goes on and on.

We've decided to do it again this winter, and start it right now. So, treat that trusty old steed with the love and dedication that it deserves and get it running and looking brand new! Bring it in to R+E Cycles (before the end of November) and have it reincarnated for just \$425! (That's way less than a new bike.)

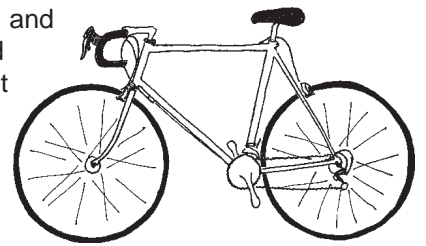

Reincarnation for your Bike

Use this coupon to save \$225 when you bring it in to Seattle Bike Repair for reincarnation.

We'll give your bike a complete overhaul and a one-color paint job for just \$425.

Reg. \$650

SAVE \$225!!

Offer good with coupon only. No cash value. Not good with any other offer. Expires Oct. 15, 2005

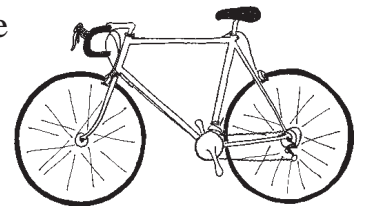

Brushing Up!

The Park Chain Cleaning system has brushes and solvent to clean the grime and grit off of your chain. It's easy to use, and comes with everything you'll need. Your legs will appreciate not having that greasy chainring tattoo, and your chain will last longer too!

Use this coupon to SAVE 10%

Reg. \$40

With Coupon Just \$35.99



Offer good with coupon only. No cash value. Not good with any other offer. Expires 10/15/04

The End of an Era

All right, I was just informed yesterday that my next order of inner tubes will cost at least 15% more. Apparently inner tubes are going up all around. This may be the last newsletter to include this special at this price....so stock up while we've got them.

Inner Tubes

3 for \$10

Offer good with coupon only. No cash value. Not good with any other offer. Expires 10/15/04

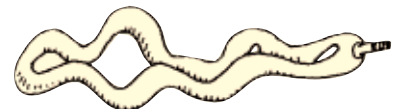

THE WORLD IS WAITING



Another Willie Weir Adventure!

August 2005

Smiley:

Just thought I'd let you and the crew know how I did on the Mt Washington Hill Climb race, the highest point in the eastern U.S.

I finished 4th in my age group and the bike worked flawlessly on the combined dirt and asphalt 7.6 mile 4727 ft climb. As far as I could tell, I had the only Rodriguez in the race. There were several Bike Fridays, and I left them in the clouds, well behind. Most of the racers were on stripped down ultralight road bikes. My finishing time was 88 minutes, just a little behind Tyler Hamilton's 52 minutes.

The Rodriguez Ultimate Travel Bike (UTB), or Willie Weir Adventure, has become an international success here at Rodriguez! It's a real touring bike that comes apart and fits into a 26"X26" suitcase. Apparently, there are a lot of people out there who want to travel with a bicycle. This year we've sent one to Japan, one to Norway, a few to Canada and I'm working with someone from Greenland currently. This will be the second year in a row that this model has outsold our projections.

There's something that we love about this bike, too. The energy from the people who have bought them after they come back from their trips. It really seems that travelling the world by bicycle can change lives, and the UTB makes that travelling a little easier. Several couples have purchased pairs of the UTBs and taken them on tours. To the right is a story written by Joseph after racing his UTB in the Mt. Washington Hill Climb.

Willie Weir is right when he says 'looking at the world from a bicycle can change your life'. The Ultimate Bicycle Traveller, Willie Weir, has been riding a Rodriguez bike like this for almost a decade. Last year, I wanted to offer an Ultimate Touring Bike at a production price. Until now, a bike of this magnitude was only available through our custom option. So I asked Willie to help me design an Ultimate Touring Bike that we can offer to our customers. He, as usual, was full of magnificent ideas and we came up with a fantastic new design.

Meet the Rodriguez Willie Weir Adventure.

Our new Ultimate Travel Bike (UTB)

This bike is rugged, well thoughtout, designed by someone whose life is bicycle touring, and handbuilt right here in Seattle by a company with over 30 years in the business. If you want to ride without being limited to smooth, paved roads, this is your bike. If you want go continent hopping, and bring your bike along for fun, this is your bike. If you want to have the experience of a lifetime on a bicycle, this is your bike. The Rodriguez Willie Weir Adventure is ready for anything. Come in and try one out! Now you can own a Rodriguez UTB for the unbelievable price of just \$2,299!



The Ultimate Travel Bike may not be the perfect {racing} machine, weighing a bit more {at 23 lbs} than my carbon Trek 5900, but it made traveling to New Hampshire a breeze, and the set-up and take down are easy after you do it a few times. I am planning a repeat visit for the 2006 race, and hope to win my age group next year.

The 1-inch road tires worked great, and the gearing also worked out well, as I needed the 28-32 combo for the 22% grade at the finish. See enclosed photo.

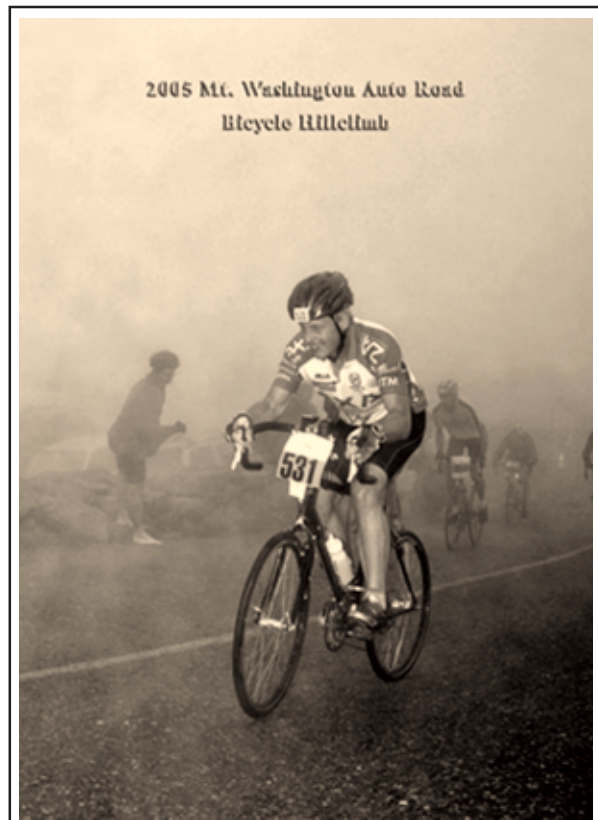

Sincerely,

Joseph P Dillard, M.D.
Billings, Montana

To read more stories from from Rodriguez customers, visit our online customer scrap book at www.rodcycle.com

Make sure to attend the Willie Weir Travel Clinic in October! See Page 1 for details

Stretch Your Budget...

...not your chain! If you let your chain stretch, it will wear out your gears on the back and front of your bike. That's hard on the budgets. Your chain should be checked for stretch at 1500 miles or so. Bring in this coupon with your bike, and we'll measure your chain and lubricate it while you wait for FREE. You got nothin' to loose...what are you waiting for?

FREE chain inspection and lube

Offer good with coupon only. No cash value. Not good with any other offer. Expires 10/15/04

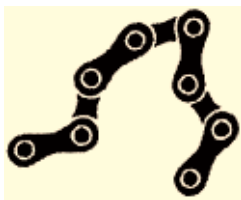

That's Just Tough!!

If you think flat tires are just one of those tough facts of life....think again. This winter you can install Mr. Tuffies tire liners and protect your tires from glass cuts and thorn punctures. Use this coupon to save \$3 when you buy a pair of them for your bicycle. Reg. \$17.

With Coupon Just \$13.99

While supply lasts

Offer good with coupon only. No cash value. Not good with any other offer. Expires 10/15/04

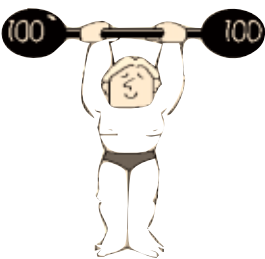

592 Days on Mars!

Here's some trivia for you. Did you know that the Mars Rover was designed to roll around Mars for 90 days. Well, as of today (Sept. 1, 2005) it has been roving around for 592 days collecting data and sending back pictures. This has very little to do with the fact that you can purchase a Mars 3.0 tail light at R+E Cycles and save 25% to boot! I suppose one might argue that the Mars 3.0 may out perform expectations by a factor of 65....I just don't know. Reg. \$20 Sale \$14.99

SAVE 25%

Offer good with coupon only. No cash value. Not good with any other offer. Expires 10/15/04

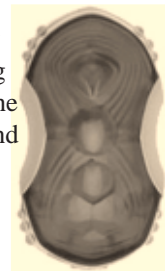

That's One Small Tool!

But it serves many big functions! The Serfas Mentor Mini tool has as much function packed into a mini tool as you can possibly imagine. Now you can fix those widgets, snickels and schnoogles yourself. No more standing on the road side waiting for the generous stranger to happen along. We'll even help you out with a \$5 discount. Reg. \$30

WITH COUPON JUST \$24.99

Offer good with coupon only. No cash value. Not good with any other offer. Expires 10/15/04



TIME TO WINTERIZE!

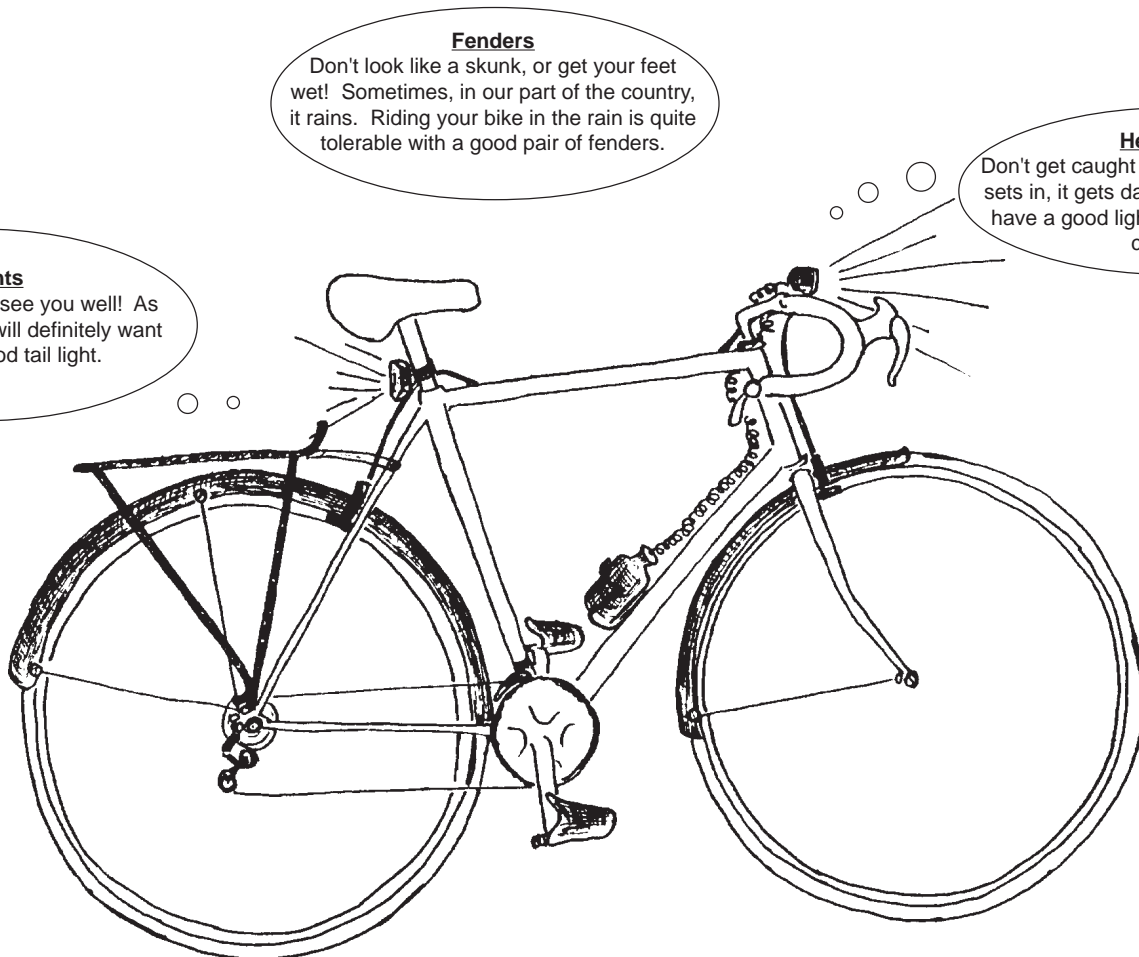

Fenders

Don't look like a skunk, or get your feet wet! Sometimes, in our part of the country, it rains. Riding your bike in the rain is quite tolerable with a good pair of fenders.

Head Lights

Don't get caught in the dark! As the winter sets in, it gets dark very early. It is vital to have a good light, especially if you are a commuter.

Tail Lights

Make sure drivers can see you well! As the winter sets in, you will definitely want some form of good tail light.

Racks

Winter riding requires a few more pieces of clothing. Make sure you have a rack, or a good way to carry the layers of clothing that you'll need to take with you....just in case....

Winter Tires

Nobody likes changing flat tires in the rain! The wet winter roads mean more glass will stick to your tires. A good set of puncture resistant tires is recommended, and very affordable.

Still the one!

Every year at R+E Cycles, we sell lots & lots of lighting systems to cyclists who ride in the dark. In the winter, it is dark at 5:00 PM, and some people like to have the finest lighting system available. There are several things that make a lighting system great:

- Brightness (will it light up the road, or is it just a safety precaution?)
- Burn time of the battery (will it give you good light for your full ride?)
- Reliability (what experiences have others had with the system?)
- Warranty (how long will you be without your lights if they break?)
- Value (does it fit your budget?)

Over the years, we have found that several of the lighting systems on the market measure up in some or most of these qualities, but only one meets all of them. The CYGOLITE™ systems are the lights that we have chosen to be our featured light systems. This year we have selected 3 CYGOLITE™ Night Rover models to serve the Northwest cyclist:

System 1 \$79.99

- 12.5 Watt Halogen
- 3-beam patterns
- 3 hour 6V gel pack battery
- Quick release mount
- Front mount battery pouch
- 1-year warranty on lights
- 3-month battery warranty
- Upgradeable to helmet mount

System 2 \$109.99

- 12 Watt Halogen
- 3-beam patterns
- 3 hour NiMH battery
- Quick release mount
- Lightweight bottle cage mounted battery**
- 1-year warranty on lights
- 3-month battery warranty
- Upgradeable to helmet mount

System 3 \$139.99

- 16.3 Watt Halogen
- 3-beam patterns
- 6 hour battery burn time**
- Quick release mount
- Battery mounts in bottle cage**
- 1-year warranty on lights
- 3-month battery warranty
- Upgradeable to helmet mount

**CYGO-LITE
IS STILL OUR FAVORITE!!**



The best feature for any of these systems is not something that one can see immediately in the product. It's the quality of the product, and CYGOLITE's willingness to stand behind that product.

What happens if your light fails under warranty??

Our policy, when possible, is to give the customer a new light if theirs fails under warranty, instead of sending it in for repair while the customer waits (sometimes a month or more). In the past, we have had a hard time with the lighting companies standing behind their product, even on a very expensive light. We found a high number of failures in almost every brand that we carried, and no willingness on their part to send us a replacement light. CYGOLITE-We have sold CYGOLITE product since 1996, and had the lowest failure rate that we have ever experienced in a lighting system. On the rare occasion that there is a warranty failure, the customer has left our store with a new part.....no waiting, and CYGOLITE took care of sending us a new product pronto!

Don't Get Caught in the Dark!

Buy a Cygo-Lite system 2 (109.99) or system 3 (139.99) and we'll give you the best flashing tail light around. The Vista classic flashing tail light is super bright, and we're givin' it to you FREE.

HURRY, supply is limited to stock

\$15 Value

Offer good with coupon only. No cash value. Not good with any other offer. Expires 10/15/04



Bright Idea!

The Serfas LED headlight is the perfect choice if you are trying to get noticed by drivers when you're riding in the dark (5:00 pm in the winter), or in the rain. It can be set to flash, or to a steady beam to light up the road. The LED lights save on batteries, and the quick release mount allows you to easily remove the light. Reg. \$30

With Coupon \$24.99

Offer good with coupon only. No cash value. Not good with any other offer. Expires 10/15/04



We Have The Best Customers In The World!!



Wed, 1 June 2005

Morning Everybody!!

I thought that I would send a picture of both our bikes however we all know that the best one is in front!!! Thanks so much for building such an awesome bike for me. I love it!!! I rode 36 miles on Monday and improved my time a lot!!! It took me under 3 hours. Not to mention that Pink is absolutely the best color for a bike.

Thanks again!
- Carmel

Meet Dale and Carmel. About a year ago, Dale bought a Rodriguez Arrow Race. Shortly after that, Carmel bought a Stellar Tour. She had Teresa paint her bike the pinkest color I have ever seen! I'm color blind, and the bike looked Pink to me! Before we assembled the bike, we had it hanging in the retail area, and everyone oohed and awed a lot. Teresa (our painter) told me that she wants to paint her own bike that color. Even in the black and white photo above, her bike still looks pink to me.

Carmel is a great cook! She took notice of the fact that during the busy season, we often have a hard time getting lunch on Saturdays. She did something about it. Sometimes on a Saturday, she brings a hot lunch for the staff (the staff thanks you greatly Carmel). One Saturday she brought some of the best spaghetti in the world. Nicholas (my 7 year old boy) had 2 helpings, and the stains are still in his shirt.

It's been great to watch Dale and Carmel get into cycling. Their enthusiasm for the sport is contagious. They were in yesterday while preparing for a weekend cycling tour. I hope the weather cooperates.

Last month, Dale upgraded his ride to one of the Rodriguez Ultra-lights, and has been burning up the roads with a fury!

Thanks for choosing us to build your bicycles (and for making us lunch too), and we wish you many happy miles ahead.

To read more stories like this one, visit our online customer scrap book at

www.rodcycle.com

Jump In The Lake!!

And save 50% while you're doing it! We've got some Lake shoes on closeout, and with this coupon you can save 50% off of the regular price of \$110. \$55 is a screamin' deal for a good quality pair of cycling shoes. Limited to supply on hand!

SAVE 50%

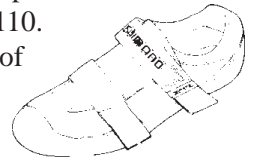

Offer good with coupon only. No cash value. Not good with any other offer. Expires Oct. 15, 2005

Get The Spin!

The Cateye Astrale computer is the only one that we carry that provides you with your cadence (how fast you are spinning). We only carry the Astrale because it is the best of the cadence computers that we've found. Use this coupon to get one for just \$39.99 (reg. \$50). While supply lasts.

SAVE \$10!



Offer good with coupon only. No cash value. Not good with any other offer. Expires 10/15/04

Clearly a Great Deal!

It's going to start getting dark early. Do you know what that means? You won't be able to see the road on your way home from work while wearing your sunglasses. But, if you don't wear your sunglasses, your eyes will water and burn. What ever will you do? We've got your problem solved. Use this coupon to get 2 pair of winter eye protection for the price of one. Reg. \$20 each. We've got clear, and amber colored lenses that work well for fog, rain, dawn or dusk.

2 pair for \$20

Offer good with coupon only. No cash value. Not good with any other offer. Expires 10/15/04

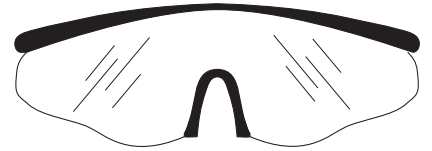

Our Shorts are Half Off!

Hey, no problem. We'll set you up with any pair of bike shorts in stock for 50% OFF! Wow! Now that's a great deal. Limited to stock on hand. Reg. \$30-\$40

SAVE 50%



Offer good with coupon only. No cash value. Not good with any other offer. Expires 10/15/04

The Dog Days of Summer

The Dog Days of summer may be gone for this season, but those pesky wolves keep on creepin' around. Keep your bike from becoming their prey with the Akita resettable combo lock. Use this coupon to save \$3 while supplies last. Reg. \$25

Just \$21.99



Offer good with coupon only. No cash value. Not good with any other offer. Expires 10/15/04

Doggonit!!

Don't find yourself saying Doggonit when your bike is gone! Use this big dog to protect your investment. The Oguard Rotweiler is the best protection you can ask for and it's on sale now at R+E Cycles. Reg. \$35

With Coupon \$29.99

Offer good with coupon only. No cash value. Not good with any other offer. Expires 10/15/04

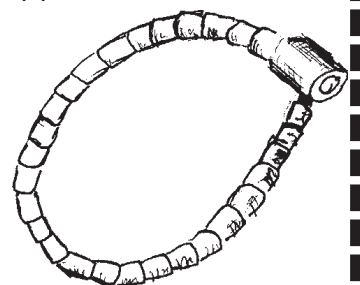

Back To School?

A great winter commuting bike. Every year at this time we sell a lot of road bikes with flat bars. The KHS Flite 200 is 2-3 pounds lighter than the bikes that we've carried in the past, it comes equipped with fenders (a \$70 option if you include installation), and it's still priced \$100 less than the bikes that we've carried in the past! Wow, what a deal! If you are looking, or you know someone who's looking, for a 700c lightweight bike for road riding, let them know that we are stocking the KHS Flite 200, and we have them on sale now for just \$429.99 (Reg. \$530)!

SAVE \$100!

KHS Flight 200

- *Lightweight Aluminum Frame
 - *Shimano Drive Train
 - *Excellent Fitness Bike
 - *Includes Fenders
- Reg. \$469.99
Special \$429.99



Stealing The Show!

Smiley asked me to bring in my bike for a customer to try (we were out of 57cm men's bikes), and then he sold it (I should've known that if it's not nailed down, Smiley will sell it). I don't know if that was the plan or not, but I assumed that my yearly trip to Idaho would have to be a tandem-only trip, as I didn't have a road bike anymore.

When the employees surprised me with a new S3 bike the day before I was leaving, I was shocked. I don't know how they got it built, painted and assembled without me ever catching on, but somehow they managed.

What a great ride it was! I had ridden the test ride bike and new that the Rodriguez S3 was a responsive bike, but on the chip seal in Idaho, I appreciated it even more. The comfort of the bike was sensational, and made me realize even more why this bike has received such a great response from those who have purchased them.

Thanks again everyone at the shop for the great surprise!

RODRIGUEZ BICYCLES



The Rodriguez S3 custom bike for men and women has remained a huge success since its introduction at Seattle Bike Expo. The blend of comfort and unparalleled performance is the big draw to this bike. Here's a bike that tips the scales at 15-18 pounds (depending on size and component choices) that is comfortable enough to ride everyday. We've built these for all-out racing, as well as the weekend warrior, with a more relaxed configuration. If you're considering a high-end road bike of any kind, this one is worth checking out!

Now that it's September, we usually expect a drop in the custom bike orders. This year, however, we've seen an August surge in S3 custom orders, and we just sold 2 more today (Sept. 1st).

We know that this surge is because you Rodriguez S3 owners are spreading the word, and we want to thank you for that.

Now that the season is winding down, it's the perfect time to put in an order and have your new S3 ready for next spring.



Read what customers are saying about these and other Rodriguez bikes on our on-line scrap book. www.rodcycle.com

7 Years of Bad Luck

I think we must have broken one of these once, and the curse was that we would still have them in stock after seven years. We don't sell a lot of mountain bikes anymore, but for some reason we have a supply of these mountain mirrors, and they've been here about 7 years. Well, the curse is up, and we're ready to sell them. They are a very high quality rear view mirror that mounts on a mountain style handle bar.

Perfect for the commuter. Reg. \$20

SALE ONLY \$6

Somebody...anybody....please buy one of these

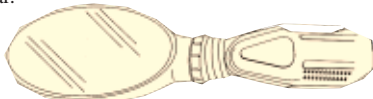

Offer good with coupon only. No cash value. Not good with any other offer. Expires Oct. 15, 2005

Catch The Metro!

A super sweet handle bar bag! Small footprint keeps your flight deck uncluttered, and your STI shifters swingin'. Main compartment holds your essentials. Front organizer pocket. Slim-profile KlickFix attachment. Shoulder strap. H2O proof zipper. Reflective piping and patch. Volume=150 cubic inches Reg. \$50

Use this coupon to save \$10 on the De-tours Metro Handle bar bag. Limited to stock on hand.

With Coupon Just \$39.99

Offer good with coupon only. No cash value. Not good with any other offer. Expires Oct. 15, 2005



Catch The Shuttle!

Same great design as the Metro handlebar bag, but a little bigger, and a large mouth opening system. Detachable clear-view map holder. Shoulder strap. H2O proof zipper. Reflective piping and patch. Raincover included. Volume-200 cubic inch Reg. \$60

With Coupon Just \$49.99

Offer good with coupon only. No cash value. Not good with any other offer. Expires Oct. 15, 2005



New Jersey

Time for a new Jersey! Use this coupon to save 20% on any of our short-sleeve jerseys in stock.

SAVE 20%

Offer good with coupon only. No cash value. Not good with any other offer. Expires Oct. 15, 2005

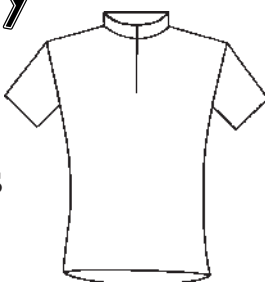

Evolution with intelligent design.

TANDEM TECH TALK

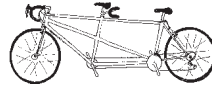

No matter where one comes down on evolution or intelligent design, we know of one place where both exist. R+E Cycles....of course.

When we joined forces with Dennis Bushnell, one of the things that we inherited (along with Dennis, Jenny and Toby) was the Bushnell eccentric business. Now, you may think that we've always been a little bit eccentric, and you would be correct, but this is a little different. In the tandem world, the eccentric is one of those components that lives on a tandem, and when functioning properly, pretty much goes unnoticed. It's the part of the tandem frame that the captain's bottom bracket (where the crank arms mount) is installed. As the timing chain (the chain that connects the captain and stoker cranks together) stretches, the eccentric allows the captain's bottom bracket to be moved forward to tighten the chain back up. It's a very necessary piece of equipment on a tandem, and now the single-speed or fixed-gear bike manufacturers have discovered this slick item for their purposes.

Up to our knees:

Dennis Bushnell pioneered the development of the eccentrics that we currently use in our Rodriguez tandems. I've always thought it was a fantastic product. When Dennis and Jenny were preparing to move their shop up to Seattle last November, Jenny called me and told me that they had orders in for 100 of the Bushnell eccentrics. She said that they could cut up the material for the 100 units and then we could machine them after the move. I suggested that they cut up the material for 400 eccentrics (100 is the biggest single run that they had done in the past).

After the move, we spent some time designing and making some new tooling to speed up production, and then Todd, Jenny and myself spent the entire month of January up to our knees in aluminum shavings making 400 Bushnell eccentrics. After that batch of 400 was done, I had a whole new respect for this quality component, and the design work that has gone into it. From January 1, 2005 we have sold nearly 900 Bushnell eccentrics.

The difference between eccentrics is hard to see from just looking at a tandem, so I thought that I would write this article and describe the different evolutions that they have gone through.

Evolution and intelligent design:

Your Great Grandfather's eccentric (prehistoric):

Before the eccentric, tandem manufacturers used an adjustable pulley wheel to take up the chain slack as the chain stretched.

Then someone (I don't know who) came up with the idea of moving the front crank forward in the frame to adjust for chain stretch. This was accomplished by mounting the captain's bottom bracket off center in an aluminum chunk that could be rotated. This idea looked a lot better than the old and caught on with most tandem manufacturers.

Your Grandfather's eccentric:

(he's really just pretending....to fool Grandma):

The early eccentrics were made from a chunk of aluminum held in place by pinch bolts on the frame. The pinch bolts could be loosened, and the chunk of aluminum could be rotated to tighten the chain. It worked pretty well, and looked a lot better than the old way. Photo 1.

Another type uses sharpened screws to dig into the aluminum chunk when tightened (instead of the pinch bolts). Photo 2.

A lot of tandem manufacturers still use these types of eccentrics today, as they are much less expensive to make.

The drawback to these types of eccentrics is that the threads on the frame can strip out, or the brazed-on threaded piece may even break off of the frame entirely. This requires a costly frame repair and paint work. The sharpened bolt style also has a gouging effect on the aluminum chunk (kind of crude we always thought).

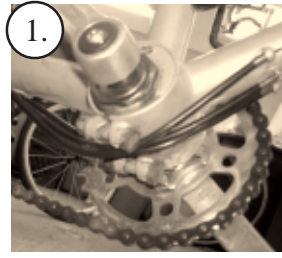

Your Father's eccentric:

In the late 1980's a company (we'll call them Large-Gun dale) came up with a design that didn't use threads on the frame, but in the eccentric itself. We're not snobs, and we recognize good design when we see it, so we switched. It used a wedge that could be tightened by a nut/bolt system. If the threads got stripped, it was just a small repair instead of a costly frame repair.

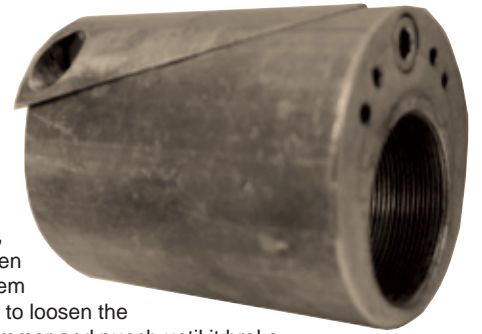

The drawback to this system was in trying to loosen it. To loosen this system properly, it required a long punch and a hammer (when someone is coming at your expensive tandem with a hammer, it's kind of scary). One had to loosen the bolt and then hit the large piece with the hammer and punch until it broke loose in the frame.

The other problem that we ran into was that non-tandem shops would loosen the bolt, and then hit the bolt head with a hammer. This would drive the threads right out of the special nut. Then we would have to red label one of the special nuts to Timbuk Tu.

The modern eccentric (the missing link):

What was missing was an intelligent design that looked good, was lightweight, and easy to adjust (even by a Neanderthal). Well, a few years after Large-Gun dale's design, the Bushnell design was born. Dennis came up with an ingenious design that used the bolt in the eccentric to both tighten and loosen the aluminum chunk in the frame. The need for the hammer and punch was gone. The Bushnell eccentric looked great in the bike, and was the easiest design to adjust as well. Like I said, we recognize good design when we see it, and we switched immediately.



Dennis then went to work improving and lightening up the design to make not only the most evolved eccentric on the market, but also the lightest and best looking.

It has now become the natural selection for manufacturers of some of the highest quality tandems and single speeds on the planet. (You didn't think that we sold 900 Rodriguez tandems since January did you?)

Function over flash:

Well, the Bushnell eccentric has gone through several evolutions to get where it is today, but is by far the best designed little piece on your Rodriguez tandem that you'll never notice.

Our choice of eccentrics over the years reflects our long held philosophy on putting the best performing products on our bicycles, not just the most 'magazine-hyped' products. The Bushnell eccentric is much more expensive to manufacture than an aluminum chunk, but it serves the bicycle owner much better in the long run.

After my experience in January, I have a new found respect for the development and manufacturing process of this incredible component, and I hope that you will too.

If you've made it this far, you're as eccentric as I am! Thanks for reading - Dan

The Eccentric

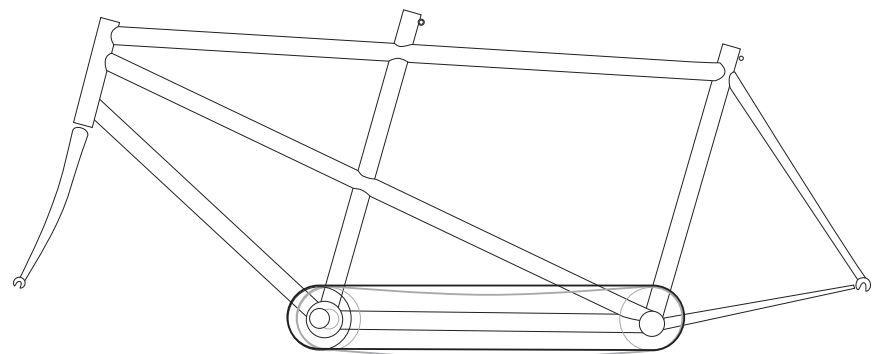

As the eccentric is rotated forward, the chain is pulled tight by the increased distance between the two crank sets.

Just The Facts Ma'am

The Sigma BC500 is a high quality, name brand computer, that gives you just what you need to know. Reg. \$25

While they last \$19.99



Offer good with coupon only. No cash value. Not good with any other offer. Expires Oct. 15, 2005

Our Favorite Sunglasses

The Serfas Sunglasses come with 4 different lenses for all types of weather. They look great for cycling or just wearing around.

Reg. \$50

SALE 20% OFF

Limited to supply on hand



Offer good with coupon only. No cash value. Not good with any other offer. Expires Oct. 15, 2005

Top of the Line!

Smith sunglasses are considered the top of the line. We've got a decent supply of them, and winter is a comin'. Now's your time to save big now, and beat next summer's high prices.

Use this coupon to get a 30% discount on any pair of Smith sunglasses that we have in stock.

30% Discount!



Offer good with coupon only. No cash value. Not good with any other offer. Expires Oct. 15, 2005



What's the Scoop?



Another Bicycle Season To Write Home About!

We at R+E Cycles want to thank all of our customers for making this season one of the best ever! 2005 will mark our second season in a row of solid growth. There's been a few times that we've run out of some models of bikes. You've been very patient with us. So far, in 2005, we've had substantial growth in just about every model that we make. A couple areas that were especially notable this year were:

Rodriguez Custom Bikes:

For the last 30+ years, we've been building custom bikes. As of September, we've built more custom bikes in 2005 than we have built in any entire year on record! We've still got 3 months to go, and several customs still in progress. 2005 already is, and will be a record custom bike year at R+E Cycles.

Rodriguez Tandems:

We've been building tandems for as long or longer than anyone in the U.S. (who is still operating). Through the late 1990's we saw the tandem market drop off substantially. During those lean years, several manufacturers left the market or went out of business entirely.

Well, tandems have returned over the past 2 years to the pre-1997 levels. I love tandem riding, and I welcome the resurgence. Dennis has more experience building tandems than anyone that I've ever met, so we're poised to build even more tandems next year.

Men's Race and Sport Bikes:

This department is almost double of last year, which was almost double of the year before. I partially attribute this to great value. The fact that we are producing so many more bikes than we ever have in the past has allowed us to purchase our components in much larger quantities direct from manufacturers instead of through

a middle man. Since we are selling direct to the public and not trying to set up dealers, we are able to sell a bicycle to the customer for the same price we would have to sell the bike to a dealer (who would then have to mark it up for his profit).

These 2 factors together add up to very competitive pricing for the Rodriguez bicycles in general. We can hand build bicycles one at a time right here in Seattle, and still sell them at a price that beats mass produced bicycles made in foreign countries.

Willie Weir Adventure (Travel Bike):

Wow! This model has really caught on world wide. Customers tell me again and again that our price on this bike is \$800 to \$1000 lower than our competition. The internet plays a role in the increase on this bike as well. We're shipping these bikes all over the world to customers that we only communicate with via email.

Women's Bikes:

The Rodriguez Stellar bikes for women remain strong in every model. The Stellar SL model saw significant growth this year, and the Stellar Sport and Stellar Tour are both on track to beat last year's sales by a small amount as well.

We'd like to thank you:

The truth is, none of this growth would be possible without the support of our customers. On any given day, a customer will come in looking for new bike and I'll ask them how they heard about our store. The answer is almost always "my friend got a bike here, and told me I needed to come here". You've been telling your friends about us, and we want to thank you for that.

We truly have The Best Customers In The World!

Meet The Crew!

Use this coupon to have a free tour of the frame building and paint facilities on any weekday.

Offer good with coupon only. No cash value. Not good with any other offer. Expires Oct. 15, 2005

Independence Day!

All right, we gave you the coupon earlier that said we'd check your chain for free. But you're the type who wants to do things for yourself huh? Well here ya go. This is a home version of the chain stretch gauge that we use here in the shop. Use this coupon to save \$1. Reg. \$13



With Coupon Just \$11.99

Offer good with coupon only. No cash value. Not good with any other offer. Expires Oct. 15, 2005

Time to Retire?

Well, we can make that happen for you. Use this coupon to save all the installation fees when we install a set of Serfas Kevlar Belted tires on your bike. The tires are \$24.99 each, and installation runs \$16 for the pair (but we're doing that part for free, so your total cost is just \$49.98. Now anyone can afford to retire!

SAVE \$16 with this coupon

Offer good with coupon only. No cash value. Not good with any other offer. Expires Oct. 15, 2005



R+E Cycles

5627 University Way NE

Seattle, WA, 98105

206-527-4822

fax 206-527-8931

email Sales@rodcycle.com

The only shop around with a real coffee shop built right in.



www.rodcycle.com